

TransPorter BlueLine Box

Modular System for Life Science Products



deep frozen



Room Temp.



Cold Chain



Blood



Medications



BioHazardous

Transport with Total Temperature Security

BlueLine - smart and flexibel

The patented design of the multiple use BlueLine Boxes was established for the transportation of all life science products at differing constant temperatures. Due to the modular system of the cooling elements and boxes, all required storage volumes and temperatures can be achieved easily.

The TempShells and TempFrames fit precisely inside the five different sized boxes. Moreover, the 5 and 10 Liter BlueLine boxes can be used with 600ml elements and the 20, 30 and 50 Liter boxes can be used with 2 or 3 Liter elements.

Apart from the standard temperatures of +4°C, + 22°C and -30°C, elements with temperatures of -18°C, -21°C and +37°C are also available. You can choose the correct temperature element for your application.

Due to their up to 50 mm PP-insulating walls, these multiple use containers are very sturdy. The cooling elements can be properly placed in four different positions, so that no weight is placed on top of your product.

Each box is designed to take either a ThermoScan Datalogger or an RFID tag, so that the temperature can be monitored and documented throughout the transportation period.

These lightweight boxes are stackable and fitted with an ergonomic handle. A seal can be used to prevent unauthorized opening of the transport containers.

Due to the delta T Fluids used in the elements no outside power source is required; therefore any power cuts will not compromise the safety of your medication, specimen or blood product. Furthermore, the delta T Fluid elements assure a constant inner temperature and protect your goods against ambient heat and frost.

The BlueLine system is safe and simple!



Blood Transport

To ship whole blood, fresh frozen plasma, platelets and erythrocytes



BioHazardous

To transport specimen and clinical samples according to restrictions



Medications

To keep cold chain requirements of 2 to 8°C for your supplies



Blueline Features

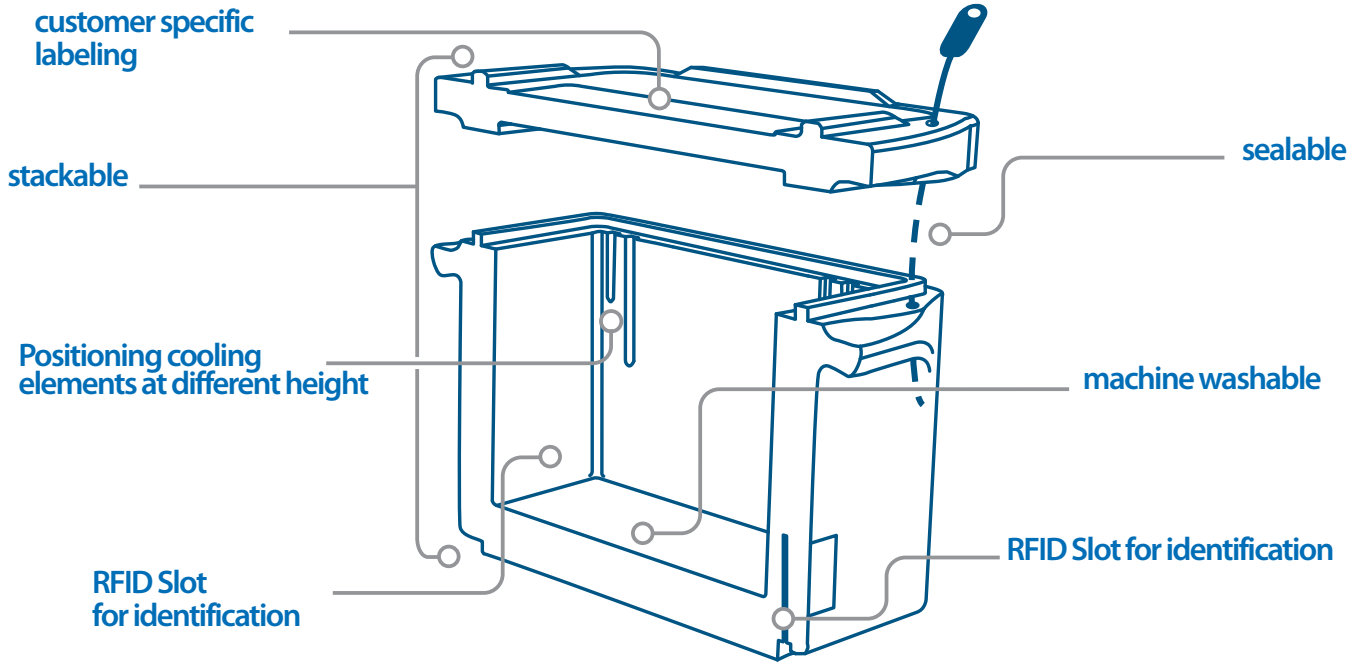

The latest polypropylene insulation technology and a wall size of up to 50 mm provides a sturdy, machine washable and highly insulated box.

Blueline Accessories



Shoulder Strap

- B 1000 91 uk (for 10L Box)
- B 1000 92 uk (for 20L Box)
- B 1000 93 uk (for 30L Box)

Strap with shoulder pad for comfortable handling
Color: black
for 10 to 30L boxes only



P650 kit

- B 0900 60 uk (for 5L Box)
- B 0900 10 uk (for 10L Box)
- B 0900 20 uk (for 20L Box)
- B 0900 30 uk (for 30L Box)
- B 0900 50 uk (for 50L Box)

Contains all necessary items, to transport goods under P650 ADR, PI650, IATA-DGR or ICAO-TI regulation standards in BlueLine Boxes.



Seal

B 1000 29 uk

To protect against manipulation
Entire length: 342 mm
consecutive number code
packaging unit: 100 pcs.



Locker & Hinges

B 1000 65 uk

same size for all boxes



Cardboard box

- B 1000 62 uk (for 5L Box)
- B 1000 61 uk (for 10L Box)
- B 1000 60 uk (for 20L Box)
- B 1000 56 uk (for 30L Box)
- B 1000 59 uk (for 50L Box)

None labeled protective cardboard packaging for long range shipment with parcel services.

LOGO



Labeling

B 1000 44 uk

Your own Logo on the Box
Lid: 297 x 105 mm
Body: 85 x 55 mm
same size for all boxes



Document holder

B 1000 43 uk

For document size of 297 x 210 mm
not available for 5L box

BlueLine Ordering Information

BlueLine 5L



Order No.: B 1000 23

Dimensions:
Outer: 464x257x230 mm
Inner: 290x170x130 mm
Weight: 1.1 kg

fits for:
1 Pair TempShells and
1 Pair TempFrame

and fits for:
2 x Akku 600ml

BlueLine 10L

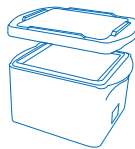

Order No.: B 1000 34

Dimensions:
Outer: 464x257x350 mm
Inner: 290x170x250 mm
Weight: 1.2 kg

fits for:
1 Pair TempShells and
2,5 Pair TempFrame

and fits for:
2 x Akku 600ml

BlueLine 20L

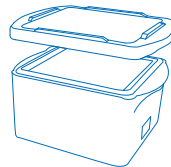

Order No.: B 1000 33

Dimensions:
Outer: 488x368x340 mm
Inner: 321x285x230 mm
Weight: 1.6 kg

fits for:
2 Pair TempShells and
5 Pair TempFrame

and fits for:
2 x Akku 2L

BlueLine 30L

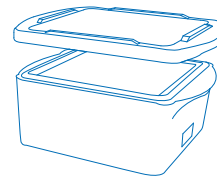

Order No.: B 1000 20

Dimensions:
Outer: 646x368x340 mm
Inner: 470x285x230 mm
Weight: 2.1 kg

fits for:
3 Pair TempShells and
7,5 Pair TempFrame

and fits for:
2 x Akku 3L

BlueLine 50L

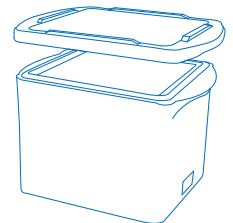

Order No.: B 1000 50

Dimensions:
Outer: 646x368x500 mm
Inner: 470x285x395 mm
Weight: 3.0 kg

fits for:
3 Pair TempShells and
18 Pair TempFrame

and fits for:
2 x Akku 3L

600ml Elements



Dimensions: 190x121x34 mm

Type:	Order No.:	Weight:
4C Akku 600mL	A 0900 11	0.5 kg
22C Akku 600mL	A 0900 12	0.5 kg
-30C Freeze El. 600 mL	A 0900 08	0.8 kg

2L Elements

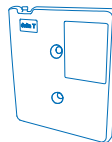

Dimensions: 319x275x35 mm

Type:	Order No.:	Weight:
4C Akku 2L	A 0900 05	2.5 kg
22C Akku 2L	A 0900 06	2.5 kg
-30C Freeze Element 2L	A 0900 01	3.6 kg

3L Elements

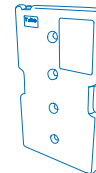

Dimensions: 465x275x35 mm

Type:	Order No.:	Weight:
4C Akku 3L	A 1000 28	3.0 kg
22C Akku 3L	A 1000 34	3.0 kg
-30C Freeze Element 3L	A 1000 04	4.5 kg

TempShells



Dimensions: 275x155x60 mm

Type:	Order No.:	Weight:
4C TempShell	A 1000 29	1.1 kg
4C TempFrame	A 1000 30	0.7 kg
22C TempShell	A 1000 35	1.1 kg
22C TempFrame	A 1000 36	0.7 kg
-30C TempShell	A 1000 05	1.6 kg
-30C TempFrame	A 1000 06	1.0 kg

TempShells



Dimensions: 275x155x60 mm

Type:	Order No.:	Weight:
4C TempShell	A 1000 29	1.1 kg
4C TempFrame	A 1000 30	0.7 kg
22C TempShell	A 1000 35	1.1 kg
22C TempFrame	A 1000 36	0.7 kg
-30C TempShell	A 1000 05	1.6 kg
-30C TempFrame	A 1000 06	1.0 kg

TempShells



Dimensions: 275x155x60 mm

Type:	Order No.:	Weight:
4C TempShell	A 1000 29	1.1 kg
4C TempFrame	A 1000 30	0.7 kg
22C TempShell	A 1000 35	1.1 kg
22C TempFrame	A 1000 36	0.7 kg
-30C TempShell	A 1000 05	1.6 kg
-30C TempFrame	A 1000 06	1.0 kg